

A Guide to Pallet Rack

The Cisco-Eagle Guide to Pallet Rack - How to Specify, How to Purchase to Save Money and Increase Efficiency



Selective



Drive-In



Pushback

As the most widely used pallet storage equipment in the world, pallet rack is utilized in most warehouses and manufacturing facilities. This common-sense guide to pallet rack styles, specifications, and accessories helps you identify, specify and purchase the right rack.

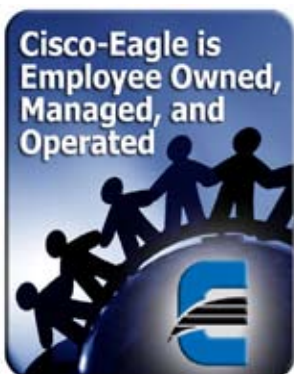

Cisco-Eagle

MATERIAL HANDLING SYSTEMS, EQUIPMENT, AND SERVICES

www.cisco-eagle.com/racks • 888-877-3861 toll-free

Dallas: (800) 441-1162 • Houston: (800) 255-0432 • San Antonio: (210) 403-2902 • Oklahoma City: (800) 522-6532 • Tulsa: (800) 722-4343 • Arkansas: (800) 482-8941

Selective Rack

The most common rack, selective provides the most selectivity and flexibility, but least storage density

Selectivity vs. Storage Density

Selective rack provides 100% selectivity for every pallet. You can always access every pallet in a selective rack system. But the compromise is less storage density—you will use more space for fewer positions because selective rack requires numerous aisles and has less storage density. It takes up space in exchange for its high degree of selectivity. For faster moving product in busy warehouse, and the best access, selective racks are the system of choice.

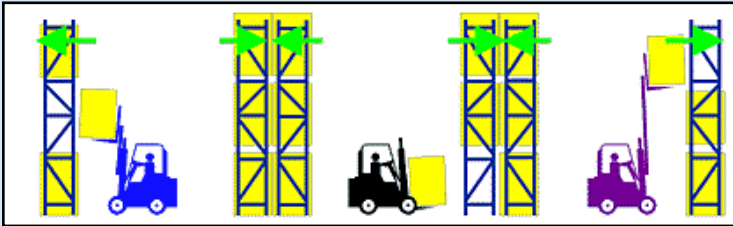

Configuring Selective Rack

Pallet & Load

(1) Determine the depth and width of your pallet.

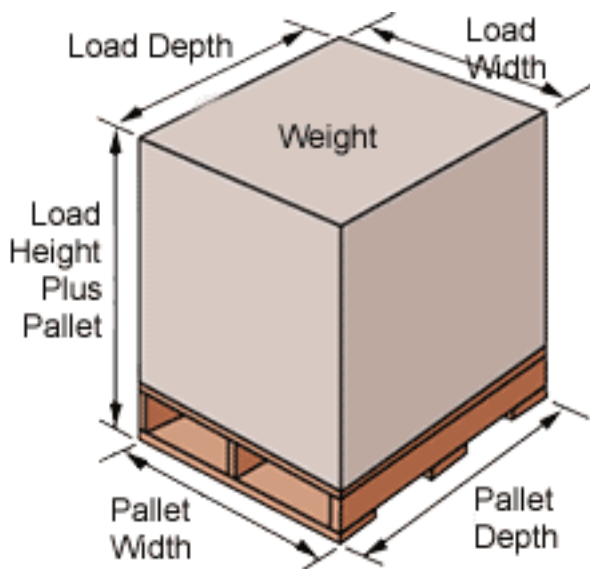

(2) Determine the load depth, load width, load height and weight of your largest load. For the height, add the height of the load and the height of the pallet together for the total. Reference Illustration: pallet rack dimensional guide

Depth

(3) Determine the front-to-back depth of your uprights: Subtract 6" from your pallet depth. Example: Your pallet is 40"W x 48"L. Subtract 6" from 48". The result: 42" uprights. See the upright chart below for our standard inventory upright sizes. Note that many others are available.

Beam Width & Capacity

(4) Determine the beam width (assumes 2 pallets per beam): Multiply load width x 2 and add 12". Exam-

ple: Load width is 42". $2 \times 42" = 84" + 12" = 96"$ beam length. If required, round up to the next highest beam length.

(5) Check the beam capacity to ensure the specified beams will carry the planned load.

Upright Height

(6) Determine your upright height:

- Multiply the number of pallets high stored minus one pallet x 10". Example: if you're storing 4 pallets high, then use multiple 3 pallets x 10". $3 \times 10" = 30"$
- Multiply the number of pallets stored minus one pallet by the overall load height. Include the pallet height in the overall load height. Example: Overall load height of 50", 4 pallets high, minus one pallet. $3 \times 50" = 150"$. (CONT.)
- Add the two numbers ($30" + 150" = 180"$ in this case). This number is your upright height.

Notes on Rack Upright Height

—The 10" between pallets allows for beam depth and space to lift and remove the pallet.

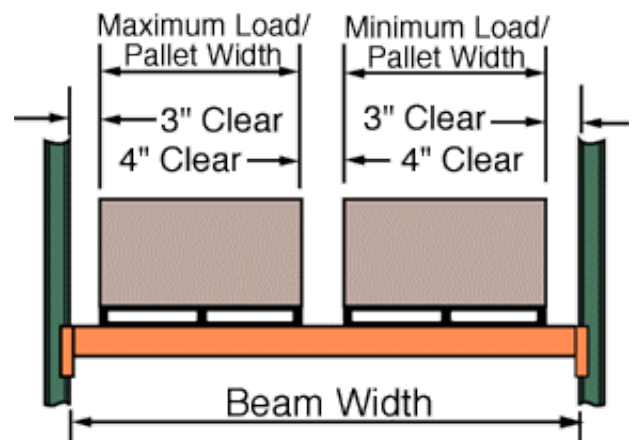

— Be certain there is adequate space left between load height of uppermost pallet and sprinkler heads, light fixtures, and other obstructions that may exist overhead.

— If you plan to store more than two pallets per beam, or more than four pallets high, or your overall pallet height is more than 60" or your pallet weight is more than 3,000 pounds, contact us for assistance.

Exclusive Online RackEstimator

To receive a racking estimate for most common configurations, visit <http://webtools.cisco-eagle.com/rack>. This free, browser-based tool lets you build a layout, drawings, parts list, and estimates including options and accessories.

Beams Inventory

Model	Capacity	Width	Beam Ht.	Wt.
SBRCP300-72	4410	72"	4"	16
SBRCP450-96	6680	96"	4.5"	26
SBRCP300-96.25	3155	96.25"	3"	21
SBRCP500-108	7030	108"	5"	31
SBRCP550-120	7370	120"	5.5"	36
SBRCG600-144	7710	144"	6"	56.5
SBRCP400-48	9190	48"	4"	13.5

Upright Frames Inventory

Model	D x H (in.)	Column	Wt.
RTFAG048120	48 x 120H	3 x 1-5/8	72
RTFAP024096	24D x 96H	3 x 1-5/8	48
RTFAP036096	36D x 96H	3 x 1-5/8	50
RTFAP036120	36D x 120H	3 x 1-5/8	58
RTFAP036144	36D x 144H	3 x 1-5/8	72
RTFAP042096	42D x 96H	3 x 1-5/8	52
RTFAP042120	42D x 120H	3 x 1-5/8	60
RTFAP042144	42D x 144H	3 x 1-5/8	75
RTFAP042168	42D x 168H	3 x 1-5/8	83
RTFAP048096	48D x 96H	3 x 1-5/8	55
RTFBP036192	36D x 192H	3 x 3	112
RTFBP042192	42D x 192H	3 x 3	116
RTFBP042216	42D x 216H	3 x 3	126
RTFBP042240	42D x 240H	3 x 3	140

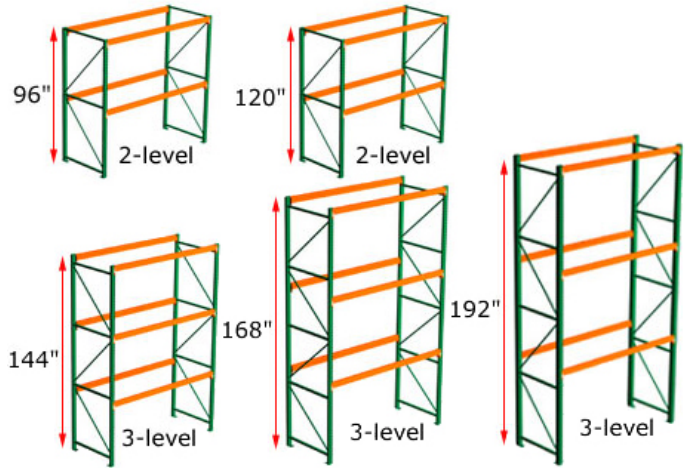

Pallet Rack Starter & Adders

For ease of specification and purchase. Units also available with wire decking. For the latest prices and extensive details, see www.cisco-eagle.com.

Model	Levels	Type	H	D	W	Cap.
2A083-24-072	2	Adder	96	24	72	4,410
2A083-36-072	2	Adder	96	36	72	4,410
2A086-36-096	2	Adder	96	36	96	6,680
2A086-42-096	2	Adder	96	42	96	6,680
2A086-48-096	2	Adder	96	48	96	6,680
2A082-24-096	2	Adder	96	24	96.25	3,155
2A082-36-096	2	Adder	96	36	96.25	3,155
2A082-42-096	2	Adder	96	42	96.25	3,155
2A082-48-096	2	Adder	96	48	96.25	3,155
2S083-24-072	2	Starter	96	24	72	4,410
2S083-36-072	2	Starter	96	36	72	4,410
2S086-36-096	2	Starter	96	36	96	6,680
2S086-42-096	2	Starter	96	42	96	6,680
2S086-48-096	2	Starter	96	48	96	6,680
2S082-24-096	2	Starter	96	24	96.25	3,155
2S082-36-096	2	Starter	96	36	96.25	3,155
2S082-42-096	2	Starter	96	42	96.25	3,155
2S082-48-096	2	Starter	96	48	96.25	3,155
2A106-36-096	2	Adder	120	36	96	6,680
2A106-42-096	2	Adder	120	42	96	6,680
2A102-36-096	2	Adder	120	36	96.25	3,155
2A102-42-096	2	Adder	120	42	96.25	3,155
2A105-36-108	2	Adder	120	36	108	7,030
2A105-42-108	2	Adder	120	42	108	7,030
2S106-36-096	2	Starter	120	36	96	6,680
2S106-42-096	2	Starter	120	42	96	6,680
2S102-36-096	2	Starter	120	36	96.25	3,155
2S102-42-096	2	Starter	120	42	96.25	3,155
2S105-36-108	2	Starter	120	36	108	7,030
2S105-42-108	2	Starter	120	42	108	7,030
3A126-36-096	3	Adder	144	36	96	6,680
3A126-42-096	3	Adder	144	42	96	6,680
3A125-42-108	3	Adder	144	42	108	7,030
3A126-42-120	3	Adder	144	42	120	7,370
3S126-36-096	3	Starter	144	36	96	6,680
3S126-42-096	3	Starter	144	42	96	6,680
3S125-42-108	3	Starter	144	42	108	7,030
3S126-42-120	3	Starter	144	42	120	7,370
3A146-42-096	3	Adder	168	42	96	6,680
3A145-42-108	3	Adder	168	42	108	7,030
3A146-42-120	3	Adder	168	42	120	7,370
3A146-42-144	3	Adder	168	42	144	7,710
3S146-42-096	3	Starter	168	42	96	6,680
3S145-42-108	3	Starter	168	42	108	7,030
3S146-42-120	3	Starter	168	42	120	7,370
3S146-42-144	3	Starter	168	42	144	7,710
3A166-42-096	3	Adder	192	42	96	6,680
3A165-42-108	3	Adder	192	42	108	7,030
3A166-42-120	3	Adder	192	42	120	7,370
3S166-42-096	3	Starter	192	42	96	6,680
3S165-42-108	3	Starter	192	42	108	7,030
3S166-42-120	3	Starter	192	42	120	7,370

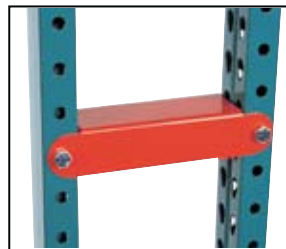

Left: wire deck; right frame spacers

Accessories

Model	Type	Specs	Wt.
FPS3D012	12" h Post Protector	for 3" Posts	10
FPS3D018	18" h Post Protector	for 3" Posts	14
PDSSG036	36" d Support	Drop in Style	5.5
PDSSG042	42" d Support	Drop in Style	6
PDSSG048	48" d Support	Drop in Style	7
RSR3G008	8" d Frame Spacer	Back to Back Style	1.4
RSR3G012	12" d Frame Spacer	Back to Back Style	2.4
N3646-3-1	36 x 46 Wire Deck	2973 lb. cap.	21
N4246-3-1	42 x 46 Wire Deck	2549 lb. cap.	25.2
N4252-4-1	42 x 52 Wire Deck	3333 lb. cap.	30.2
N4258-4-1	42 x 58 Wire Deck	3374 lb. cap.	32.1

Pushback & Pallet Flow

High storage density, first-in, first-out storage

Aisles virtually disappear

Unsurpassed storage density is the key strength of flow rack systems. The amount of stored pallets is limited only by the size of your facility; very few aisles are needed. Flow storage systems offer automatic “first-in, first-out” product rotation, an advantage with perishable and time-sensitive products. Flow storage is the ultimate in high density storage, with the product access limited to the front of the system.

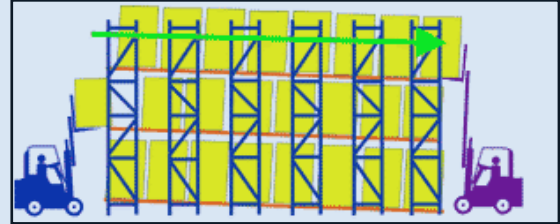

Pushback Rack

How Push Back Racks work



Pallets are placed by forklift on nested carts riding on inclined rails. Each pallet is then pushed back by subsequent pallet loading, exposing the next cart. When removing product, the forklift takes out the front pallet, allowing the pallets on carts behind it to roll gently to the front of the rack. The

nested carts make placement and retrieval easy. It fills the storage cube with product, not aisles. A Pushback rack system lets you store pallets 2 to 5 deep while retaining easy access to a variety of different SKUs.

Advantages

- Better use of space - Push back offers up to 90% more product storage than selective rack systems
- Store a variety of SKUs on different levels of lanes for easy access
- Interlocking carts help prevent dangerous jamming and costly product damage
- Up to 400% more selectivity than drive-in racks
- Color coded carts for easy visual inventory
- Large target for loading and unloading
- Maximizes space utilization with “last in, first out” inventory control.

Pallet Flow Rack

Flow Storage consists of two elements: a static rack structure and dynamic flow rails. The flow rails are a track/roller system set at a decline along the length of the rack. Flow rails allow loads to move by gravity from the loading end to the unloading end. Each flow lane includes self-energized speed controllers (brakes) to gently control the speed of movement within the flow lanes. As a load is removed, the loads behind it move forward to the unloading position. The flow system depth, height, and width are limited only by the size of your facility and the capabilities of your material handling equipment.

The Advantages of Pallet Flow

Loads are transported via the flow rails from the loading end to the unloading end of the storage system. The first load in is always the first load to be taken out. This stock rotation is especially beneficial with perishable or time-sensitive goods.

Once loaded, product rotation is automatic. The rack eliminates labor and fork truck operation to rearrange loads. And Steel King flow rails are powered by gravity, requiring no electricity or other utilities.

Fewer fork lifts, operating fewer hours, and consuming less fuel can accomplish the same handling function. With only two aisles, each dedicated to specific functions (loading or unloading), traffic is more orderly, employees are more efficient and overall productivity is improved.

Because storage density can be doubled, storage capacity can be increased within the same storage area, or a portion of your existing storage area can be made available for other uses.

By increasing storage capacity within existing facilities, the need for new construction could be eliminated. When new construction is necessary, building size and cost can be reduced by up to 50 percent. A smaller warehousing area, in turn, can reduce insurance, land acquisition costs, and taxes.

Higher density storage and consequently smaller storage areas also mean less area to heat, illuminate, air condition, and/or refrigerate.

Drive-in & Drive-Through

Allows up to 75% more pallets in the same space

Last-in, First-out dynamic storage

These systems store pallets two, three, or more deep. These kinds of rack systems offer greater storage density than selective racks, but less selectivity. They are “last-in, first-out” systems with reduced selectivity, and great product density. An excellent solution for items that have longer life in storage, and don’t require immediate access.. These racks offer greater storage density at the cost of accessibility.

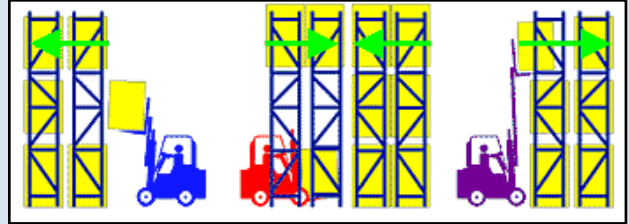

Drive-In Pallet Racks

Drive-In Racks allow a lift truck to enter the rack from one side to pick up or pull out pallets, which slide backwards on a continuous rail. Forklifts drive into the rack to access pallets two or more deep. Storage depth for a particular bay is limited by the size of your facility. It’s subject to more abuse than selective racks, so rack integrity and strength are vital. It’s ideal for cooler or freezer applications. Selectivity is sacrificed for storage density. It requires fewer aisles and is better cubic storage.

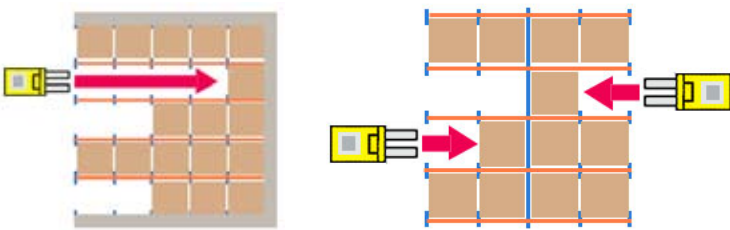

Above, left: Single Entry Racks - lift trucks can enter the rack from only one side. Right: Double Entry Racks - lift trucks can enter from both sides or a row of racks. The center of the rack row is stabilized by a beam.

When to specify Drive-In Racks

- Cold storage applications, due to the need to store as many pallets as possible in as little expensive freezer space as possible.
- When you have seasonal items that move quickly out of your inventory.
- When you have a large amount of similar items that can be stored in a single pallet position and accessed last-in, first-out
- If you don’t store a wide variety of loads in the rack.

Drive-Through Pallet Racks

Drive-Through Racks allow a lift truck to enter the rack from either side to pick up or pull out pallets. Loads are supported by rails attached to upright frames, and lift trucks are driven between uprights to reach pallets. This is done because pallets can slide backwards on a continuous rail. It’s open at both ends, allowing first-in, first-out storage.

Drive-Through Racks store a large amount of similar loads in a smaller area. Selectivity is sacrificed for storage density, as many pallets are stored and are available through a single pallet position. Requires loads of a similar width.

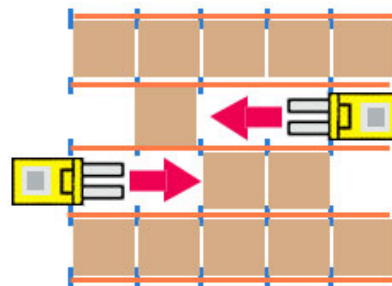

Left: Drive-Through Rack is used to store many pallets of a similar SKU or product. Lift trucks drive into the rack to extract the first pallet they come to.

When to specify Drive-Through

- Cisco-Eagle has installed Drive-In and Drive-Through Racks in a number of cold storage applications, due to the need to store as many pallets as possible in as little expensive freezer space as possible
- When you have seasonal items that move quickly out of your inventory
- When you have a large amount of similar items that can be stored in a single pallet position and accessed last-in, first-out
- If you don’t store a wide variety of loads in the rack.